

# Black Glass Towel Radiator

---

## User manual

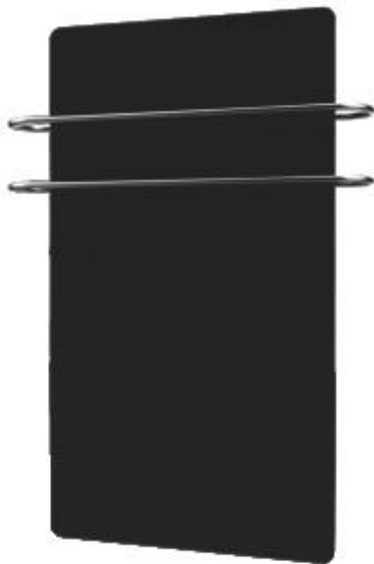

This picture is for reference only. Please carefully read this instruction before using the product.

MODEL:  
ETG500A



**IP24**

**RoHS**



---

The appliance is not intended for use by persons (including children) with reduced physical sensory or mental capabilities, or lack of experience and knowledge, unless they have been given supervision or instruction concerning use of the appliance by a person responsible for their safety.

Children should be supervised to ensure that they do not play with the appliance.

This appliance can be used by children aged from 8 years and above and persons with reduced physical, sensory or mental capabilities or lack of experience and knowledge if they have been given supervision or instruction concerning use of the appliance in a safe way and understand the hazards involved.

Children shall not play with the appliance.

Cleaning and user maintenance shall not be made by children without supervision.

Children of less than 3 years should be kept away unless continuously supervised.

Children aged from 3 years and less than 8 years shall only switch on/off the appliance provided that it has been placed or installed in its intended normal operating position and they have been given supervision or instruction concerning use of the appliance in a safe way and understand the hazards involved. Children aged from 3 years and less than 8 years shall not plug in, regulate and clean the appliance or perform user maintenance.

---

## Product in the carton

Once open the carton, pls. check everything is complete in the package, they are as follows:

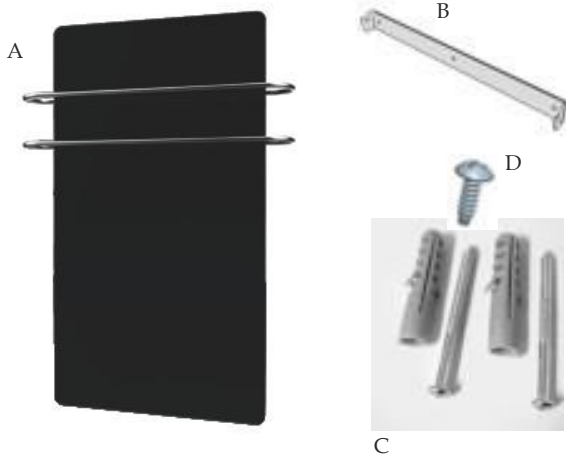

PART CODE	NAME	QUANTITY
A	Bathroom Heater	1 pcs
B	Hook	2 pcs
C	Expansion Screw	4 pcs
D	Screw	4 pcs

Product specification and model

Model	Output Power (W)	Frequency	Rated Voltage	DuStproof and Waterproof Grade
ETG500A	500	50Hz	220~240V	IP24

# Safety and cautions

---

1. The quality guarantee service excludes damages caused by failure to abide by this instruction.

2. The product must be connected to a power supply that conforms to the rated voltage marked on the label of the electrical apparatus.

3. The product should not be used near coal gas, explosive or flammable and combustible materials.



4. Warning: In order to avoid overheating, do not cover the heater.

5. The surface temperature will become higher in operation.

6. Warning: The heater must not be used if the glass panels are damaged.

7. Do not install the heater right below a socket.

8. The product should not be connected to power source before maintenance or cleaning is finished.

9. The product is only applicable for indoor use.

10. If the supply cord is damaged, it must be replaced by the manufacturer, its service agent or a similarly qualified person in order to avoid a hazard.

11. The appliance shall be installed so that switches and other controls cannot be touched by a person in the bath.

## Safety and cautions

---

12. Residual current protective devices (RCDs) with a rated residual operating current not exceeding 30mA shall be provided protection for all the circuits.
13. Keep the Towel Rail clean. Do not allow any objects to enter any ventilation or exhaust opening as this may cause electric shock, fire or damage to the heater.
14. Do not use this heater in small rooms when they are occupied by persons not capable of leaving the room on their own, unless constant supervision is provided.
15. CAUTION- Some parts of this product can become very hot and cause burns. Particular attention has to be given where children and vulnerable people are present.
16. WARNING: In order to avoid a hazard for very young children, this appliance should be installed so that the lowest heated rail is at least 600 mm above the floor.
17. The maximum carrying capacity of towel rack is 5 Kg.

# Selection of use site

---

1. This wall-mounted heater should be installed at a proper position.
2. It should not be installed near furniture, curtains or other electrical appliances.
3. It should not be installed at a corner of wall.
4. It should be installed far away from doors and windows.
5. It should be installed in such way that people who are having a bath or shower cannot touch the switch or controller.

## Installation instruction for a wall-mounted heater

---

The installation of the product must conform to the following requirements.

THIS FITTING MUST BE INSTALLED IN ACCORDANCE WITH IEE REGULATIONS AND BUILDING REGULATIONS.

Zone	DeScription	SuitaBiLity
0	Inside bath or shower	Not suitable
1	Within 2.25m above bath or shower basin	Not suitable
2	Within 0.6m ( horizontal) from outer edge of the bath or shower	Not suitable
3	Greater than 0.6m (horizontal) from outer edge of the bath or shower basin, or greater than 2.25m above Zone 2's floor	Suitable

# Installation instruction for a wall-mounted heater

THIS FITTING SHOULD BE INSTALLED AT LEAST 0.6M away from A BATHROOM SINK.

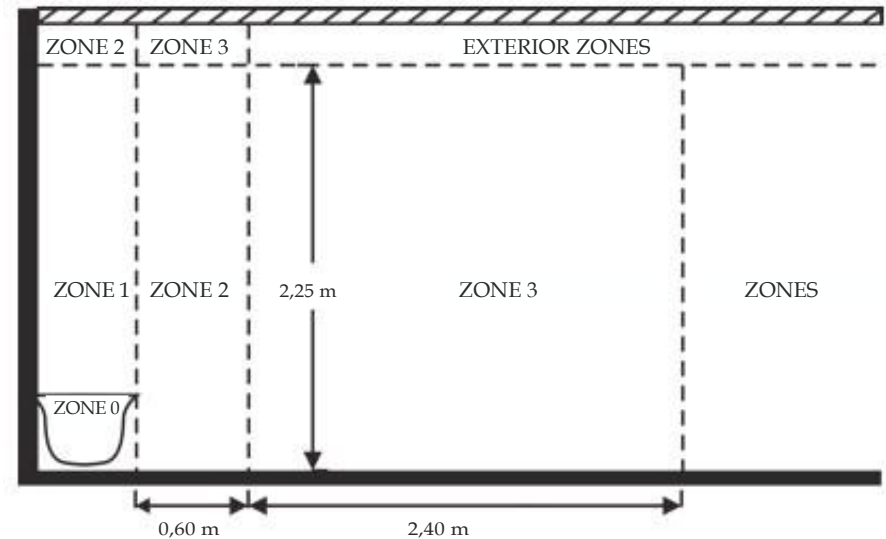

HO WEVER, IF YOU WISH TO FIT THIS PRODUCT IN A BATHROOM, IT IS SUITABLE FOR USING IN ZONE 3 AND OUT SIDE ZONE A S PER THE DIA GRAM.

1. If to install the product on the wall, please keep the distance from the wall surface as shown in the following Figure 1-1.

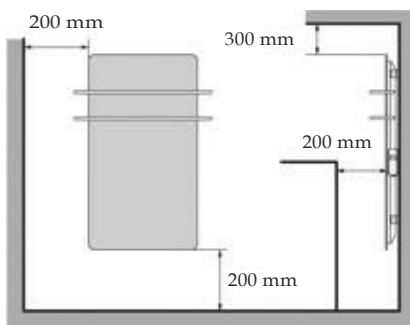

Figure 1-1

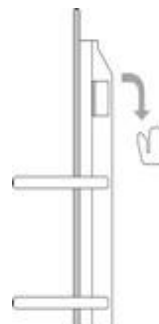

Figure 1-2

# Installation instruction for a wall-mounted heater

---

2. Fix the 2 hooks onto the wall with expansion screws provided in the accessory bag of the product. Distance is shown in Figure 1-3. When the installation position is determined, make a mark first. Drill 4 holes on the wall as shown in Figure 1-4.

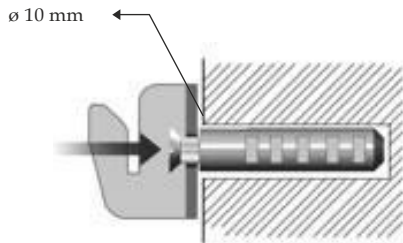
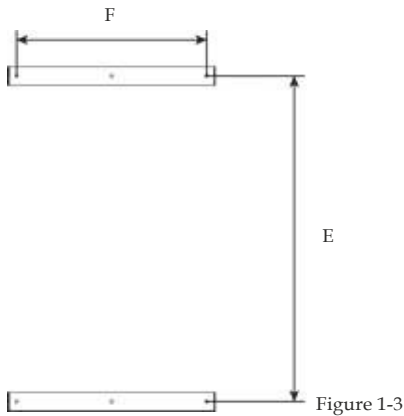

Figure 1-4

Distance marked above corresponds to that of each product as shown in the table:

Model	Distance E	Distance F
ETG500A	693	360MM

Hang the host machine of heater over the hook fixed on the wall through hook cover on the back of the heater. See Figure 1-2. Then screw down the set screws and fix the product and the hook with the 4 set screws. See Figure 1-5.



# Installation instruction for a wall-mounted heater

---

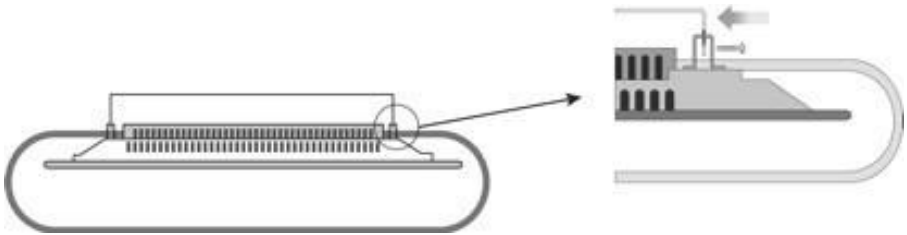

Figure 1-5

## Description of control panel

---



# Description of keys

---

1. Time Set key: Keep pressing "PROG" 3 second to set local time, reserved time and reserved working mode. Under the setting mode, keep pressing "PROG" 3 second to quit from setting; short press it to switch over among local time, reserved time and reserved working mode. Not under the setting mode, short press it to start or quit reservation function.
2. Power key: After power source is connected, press "⏻" to enter standby mode. When the heater is operating, press "⏻" to enter standby state. If the heater is switched off and then powered on again, press "⏻" to recover to the working condition before power failure.
3. (+) and (-): a. At heating mode "🔥", press "(+)" or "(-)" to regulate the range at 1-5. Press it once to increase or reduce 1 range. If without any operation, the heater will confirm this range. The new range will be saved in the machine.

1. Under time setting mode, press "(+)" or "(-)" to set current time.
2. Under reservation mode, press "(+)" or "(-)" to regulate the start time and end time for operation.
3. Key locking/unlocking: If without any operation in 60s, the screen will be automatically locked, and "🔒" displayed. The key will be automatically locked and will be unlocked by keeping pressing "(-)" key for 3s.

4. Short press "🔥" to enter heating mode. Under heating mode "🔥", press this key to quit from this mode.
5. Short press "🧺" to enter towel drying mode. Under towel drying mode "🧺", press the key to quit from the mode. "(+)" or "(-)" is invalid under towel drying mode.

NOTE: In Reservation Mode the product works to the scheduled function, if you need to change the function you must first exit the Reservation Mode.

# LCD DISPLAY

---

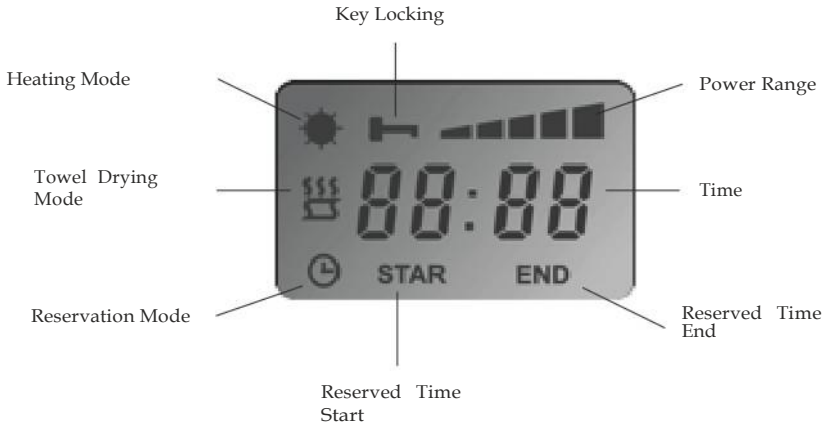

## Operation instruction

---

1. Power: Press power key. Then the power indicator will be illuminated and the heater will enter the standby state.
  - 1.1 1) Press "⏻" to start machine, press "☀️" to enter heating mode. Then "☀️" and "▬▬▬▬▬" will be displayed. "▬▬▬▬▬" default is range 5, as shown in Figure 1-6. Press "+" or "-" to regulate the range. Press "+" or "-" to increase or decrease for 1 range. Range 1 is the lowest.

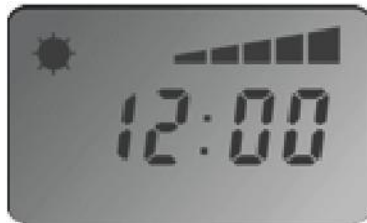

Figure 1-6

# Operation instruction

---







- 1.2. Press “” to start machine; then press “” to enter towel drying mode. The towel rails will heat separately. “” will be displayed and the heater will start operation, as shown in Figure 1-7. Or under “” the heating mode, press “” to enter towel drying mode. “” will be displayed and the heater will start operation, as shown in Figure 1-8. .



Figure 1-7



Figure 1-8

## 2. Timer switch setting

- 2.1 Keep pressing “**PROG**” for 3s to set the local time. The hour digits flicker. Press “(+)” or “(-)” to regulate the hour. Refer to Figure 1-9. Then short press “**PROG**” to set the minute digits. They flicker. Press “(+)” or “(-)” to regulate the minute. Refer to Figure 1-10.

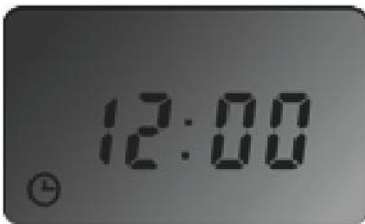

Figure 1-9

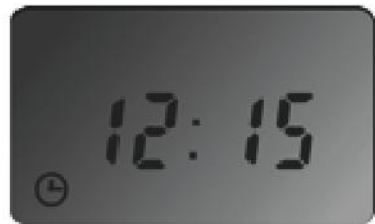

Figure 1-10

# Operation instruction

---

- 2.2 Then short press “**PROG**” to set timer Start. Press “(+)” or “(-)” to increase or decrease the time on the basis of 0.5 h. Refer to Figure 1-11. Short press “**PROG**” to set working mode, press “☀” or “☁” to set heating mode ( default full power) or towel drying mode which can work separately (refer to Figure 1-11 or Figure 1-12) or together (refer to Figure 1-13). Then short press “**PROG**” to set timer End. Press “(+)” or “(-)” to increase or decrease the time on the basis of 0.5h. Refer to Figure 1-14. The available setting range from 00:00 to 24:00. Keep pressing “**PROG**” 3 seconds to quit from the setting mode and work as the setting mode.



Figure 1-11



Figure 1-12



Figure 1-13



Figure 1-14

- 2.3 Not under the time setting mode, short press “**PROG**” to start or quit reservation function.
3. If there is no any operation in 60s, the screen will be automatically locked and “” displayed. The key will be automatically locked and unlocked by keeping pressing “(-)” for 3s.

# Daily maintenance and cleaning

---

Wipe the surface of the housing with soft cloth or special cleaning cloth for glass.

Before cleaning wait for complete cooling of radiator body.

Do not use the towel rack before drying and after cleaning.

# Troubleshooting

---

- Ensure that power supply is connected;

- Ensure that the product is powered.

In case that the above mentioned ways fail to solve problems, please contact the Technical Service.

# Recommendation for environmental protection

---



Do not dispose of electrical appliances as unsorted municipal waste, use separate collection facilities.

Contact your local government for information regarding the collection systems available.

If electrical appliances are disposed of in landfills or dumps, hazardous substances can leak into the groundwater and get into the food chain, damaging your health and well-being.

When replacing old appliances with new ones, the retailer is legally obligated to take back your old appliance for disposals at least free of charge

